

NBC-M12MSD/15,0-93E/R4AC US - Network cable



1409862

<https://www.phoenixcontact.com/us/products/1409862>

Please be informed that the data shown in this PDF document is generated from our online catalog. Please find the complete data in the user documentation. Our general terms of use for downloads are valid.

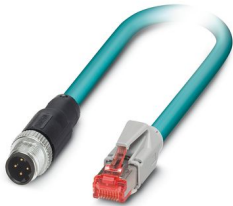

Network cable, Ethernet CAT5 (100 Mbps), 4-position halogen-free, shielded, Plug straight M12, coding: D / IP67, on Plug straight RJ45 / IP20, cable length: 15 m

Commercial data

Item number	1409862
Packing unit	1 pc
Minimum order quantity	1 pc
Sales key	BF15
Product key	BF1IHA
GTIN	4046356993029
Weight per piece (including packing)	638.8 g
Weight per piece (excluding packing)	630 g
Customs tariff number	85444290
Country of origin	US

1409862

<https://www.phoenixcontact.com/us/products/1409862>

Technical data

Product properties

Product type	Data cable preassembled
Sensor type	Ethernet
Number of positions	4
Application	Standard, U.S. cables
Shielded	yes
Coding	D

Interfaces

Bus system	Ethernet
Signal type/category	Ethernet CAT5, 100 Mbps

Signaling

Status display	No
Status display present	No

Electrical properties

Nominal voltage U_N	48 V AC
	60 V DC
Nominal current I_N	1 A
Transmission medium	Copper
Transmission characteristics (category)	CAT5 (IEC 11801:2002)

Connector

Connection 1

Type	Plug straight M12 / IP67
Coding type	D (Data)
Material	CuSn (Contact)
	Ni/Au (Contact surface)
	PA (Contact carriers)
	TPU, hardly inflammable, self-extinguishing (Grip)
	Zinc die-cast, nickel-plated (Screw connection)
Degree of protection	IP67

Connection 2

Type	Plug straight RJ45 / IP20
Material	CuSn (Contact)
	Ni/Au (Contact surface)
	PA (Contact carriers)
	PA (Housing)
Degree of protection	IP20

1409862

<https://www.phoenixcontact.com/us/products/1409862>

Cable/line

Cable length	15 m
Ethernet flexible CAT5, 2-pair [93E]	
Dimensional drawing	
Cable weight	42 kg/km
UL AWM Style	20963 (80°C/30 V)
Wiring standards/regulations	Electrical requirements EN 50288-2-2
Number of positions	4
Shielded	yes
Cable type	Ethernet flexible CAT5, 2-pair [93E]
Conductor structure	2x2xAWG26/7, SF/UTP
Signal runtime	5.3 ns/m
Conductor structure signal line	7x 0.16 mm
AWG signal line	26
Conductor cross section	2x 2x 0.14 mm ²
Wire diameter incl. insulation	0.98 mm
External cable diameter	6.4 mm ±0.2 mm
Outer sheath, material	PUR
External sheath, color	water blue RAL 5021
Conductor material	Bare Cu litz wires
Material wire insulation	Foamed PE
Single wire, color	white/orange-orange, white/green-green
Thickness, outer sheath	1.2 mm
Twisted pairs	2 cores to the pair
Overall twist	Two pairs with two fillers to the core
Optical shield covering	70 %
Insulation resistance	≥ 500 MΩ*km
Coupling resistance	≤ 100.00 mΩ/m (at 10 MHz)
Loop resistance	≤ 290.00 Ω/km
Wave impedance	100 Ω ±5 Ω (at 100 MHz)
Cable capacity	approx. 45 nF/km (at 1 kHz)
Nominal voltage, cable	≤ 100 V (Peak value, not for high-power applications)
Test voltage Core/Core	700 V (50 Hz, 1 min.)
Test voltage Core/Shield	700 V (50 Hz, 1 min.)
Current carrying capacity of cable	2 A (according to DIN VDE 0891-1)

NBC-M12MSD/15,0-93E/R4AC US - Network cable



1409862

<https://www.phoenixcontact.com/us/products/1409862>

Minimum bending radius, fixed installation	4 x D
Minimum bending radius, flexible installation	8 x D
Smallest bending radius, fixed installation	26 mm
Smallest bending radius, movable installation	52 mm
Tensile strength	≤ 80 N
Near end crosstalk attenuation (NEXT)	65.3 dB (with 1 MHz)
	56.3 dB (at 4 MHz)
	50.3 dB (at 10 MHz)
	47.2 dB (at 16 MHz)
	45.8 dB (at 20 MHz)
	42.9 dB (at 31.25 MHz)
	38.4 dB (at 62.5 MHz)
	35.3 dB (at 100 MHz)
Power-summed near end crosstalk attenuation (PSNEXT)	62.3 dB (with 1 MHz)
	53.3 dB (at 4 MHz)
	47.3 dB (at 10 MHz)
	44.2 dB (at 16 MHz)
	42.8 dB (at 20 MHz)
	39.9 dB (at 31.25 MHz)
	35.4 dB (at 62.5 MHz)
	32.3 dB (at 100 MHz)
Return attenuation (RL)	23 dB (at 4 MHz)
	24.1 dB (at 8 MHz)
	25 dB (at 10 MHz)
	25 dB (at 16 MHz)
	25 dB (at 20 MHz)
	23.6 dB (at 31.25 MHz)
	21.5 dB (at 62.5 MHz)
	20.1 dB (at 100 MHz)
Shield attenuation	3.2 dB (with 1 MHz)
	6 dB (at 4 MHz)
	9.5 dB (at 10 MHz)
	12.1 dB (at 16 MHz)
	13.6 dB (at 20 MHz)
	17.1 dB (at 31.25 MHz)
	24.8 dB (at 62.5 MHz)
	32 dB (at 100 MHz)
Halogen-free	according to IEC 60754-1
Flame resistance	according to IEC 60332-1-2
	in acc. to UL VW1
	in accordance with UN ECE-R 118.03
Resistance to oil	in accordance with EN 60811-2-1
Ambient temperature (operation)	-40 °C ... 80 °C (cable, fixed installation)
	-20 °C ... 80 °C (Cable, flexible installation)

1409862

<https://www.phoenixcontact.com/us/products/1409862>

Ambient temperature (installation)	-20 °C ... 80 °C
------------------------------------	------------------

Environmental and real-life conditions

Ambient conditions

Degree of protection	IP65 (M12 connector)
	IP67 (M12 connector)
	IP20 (RJ45 connector)
	IP67/IP20
Ambient temperature (operation)	-25 °C ... 85 °C (M12 connector)
	-25 °C ... 60 °C (RJ45 connector)

Standards and regulations

M12

Standard designation	M12 connector
Standards/specifications	IEC 61076-2-101

Drawings

Schematic diagram



Connector pin assignment plug RJ45

Dimensional drawing

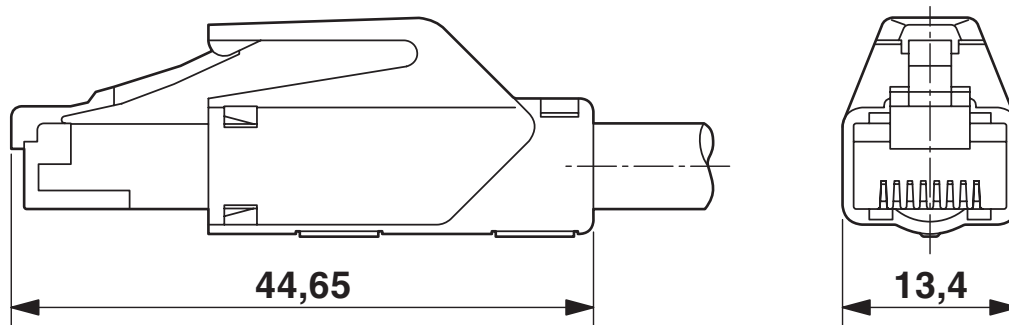

RJ45 connector, IP20

Circuit diagram

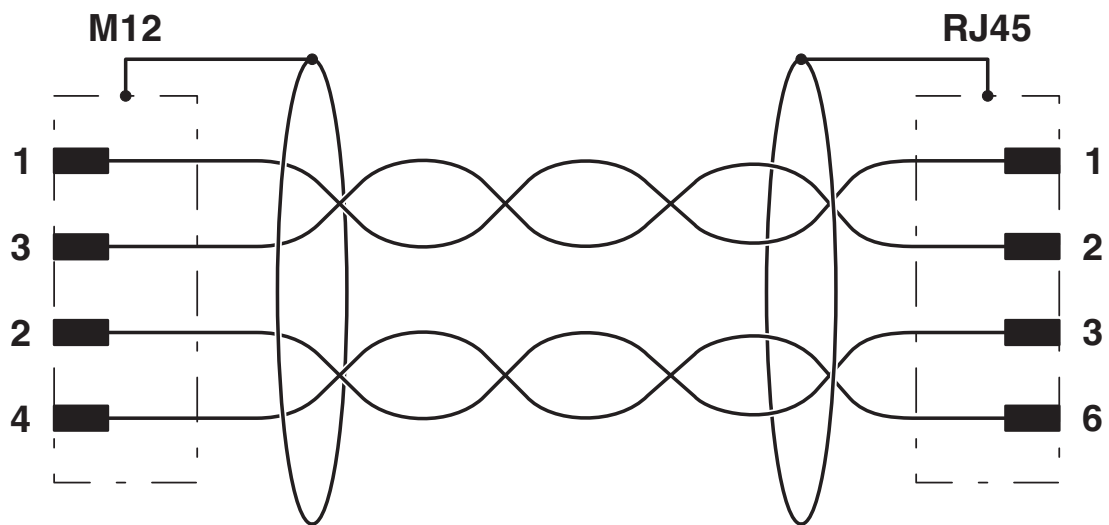

1409862

<https://www.phoenixcontact.com/us/products/1409862>

Dimensional drawing

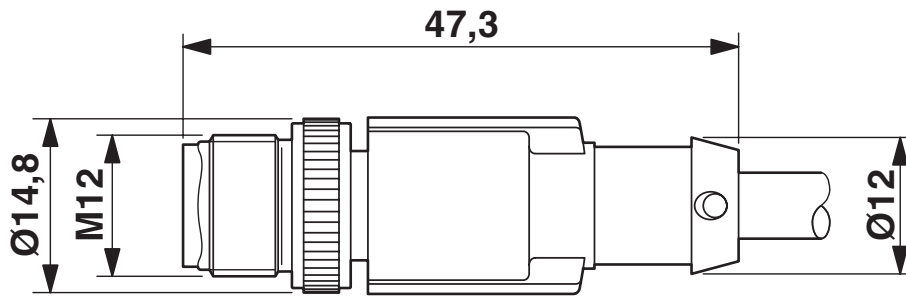

Plug, M12 x 1, straight, shielded

Schematic diagram

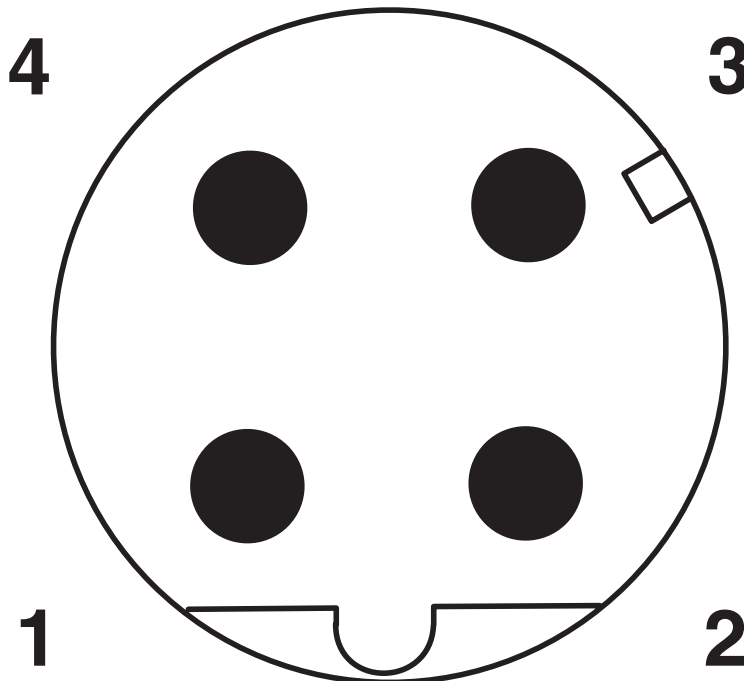

Pin assignment M12 male connector, 4-pos., D-coded, male side

1409862

<https://www.phoenixcontact.com/us/products/1409862>

Approvals

To download certificates, visit the product detail page: <https://www.phoenixcontact.com/us/products/1409862>

 UL Listed Approval ID: FILE E 335024				
	Nominal voltage U_N	Nominal current I_N	Cross section AWG	Cross section mm^2
	30 V	0.5 A	-	-

 EAC-RoHS Approval ID: RU D-DE.HB35.B.00387				
--	--	--	--	--

 cUL Listed Approval ID: FILE E 335024				
	Nominal voltage U_N	Nominal current I_N	Cross section AWG	Cross section mm^2
	30 V	0.5 A	-	-

cULus Listed				
---------------------	--	--	--	--

1409862

<https://www.phoenixcontact.com/us/products/1409862>

Classifications

ECLASS

ECLASS-11.0	27060307
ECLASS-12.0	27060307
ECLASS-13.0	27060307

ETIM

ETIM 9.0	EC001855
----------	----------

UNSPSC

UNSPSC 21.0	26121600
-------------	----------

NBC-M12MSD/15,0-93E/R4AC US - Network cable



1409862

<https://www.phoenixcontact.com/us/products/1409862>

Environmental product compliance

China RoHS	Environmentally Friendly Use Period = 50 years For information on hazardous substances, refer to the manufacturer's declaration available under "Downloads"
------------	--

Phoenix Contact 2024 © - all rights reserved
<https://www.phoenixcontact.com>

Phoenix Contact USA
586 Fulling Mill Road
Middletown, PA 17057, United States
(+717) 944-1300
info@phoenixcon.com